

הכנסת גלגל

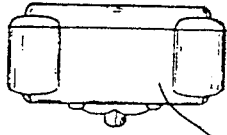

FIG-4

הכנסת גלגל

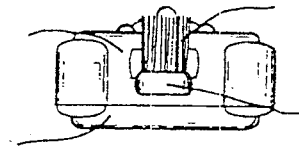

FIG-5

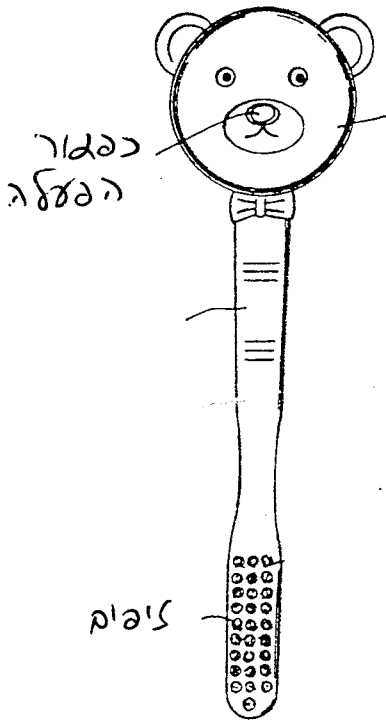

FIG-1

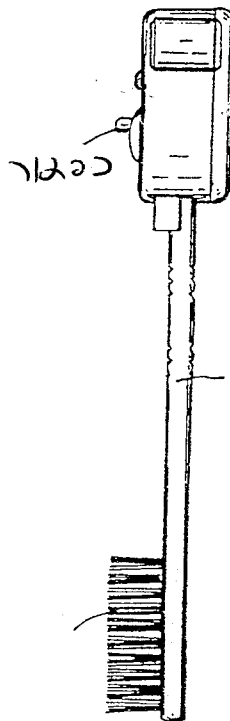

FIG-3

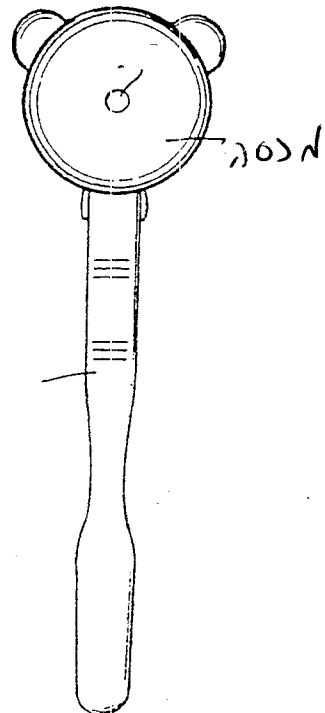

FIG-2

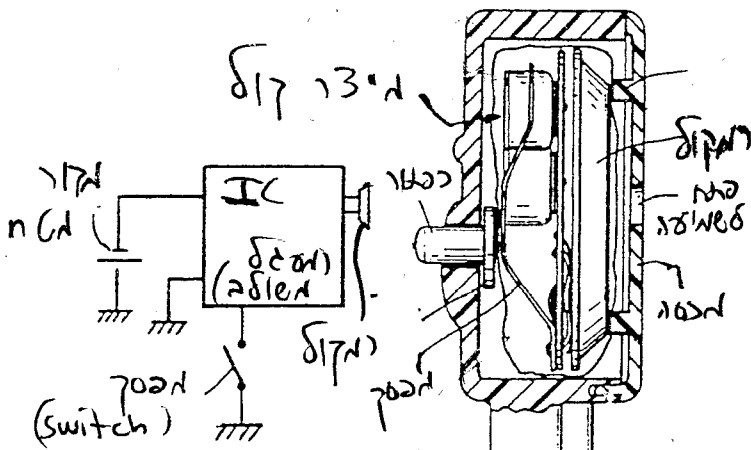

FIG-8

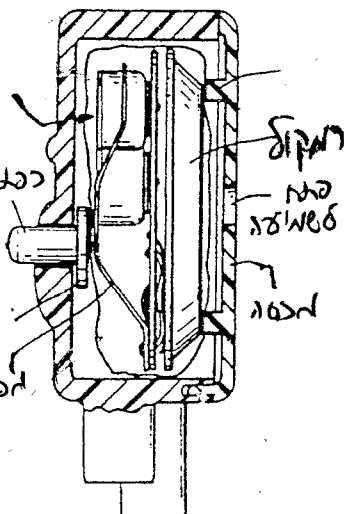

FIG-7

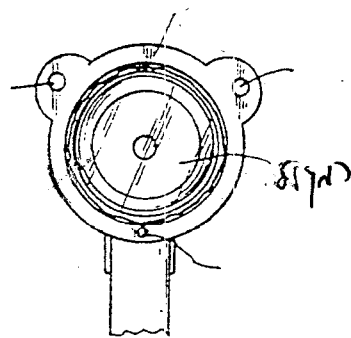

FIG-6

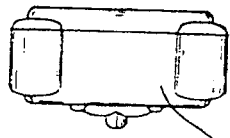

FIG-4

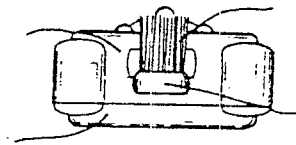

FIG-5

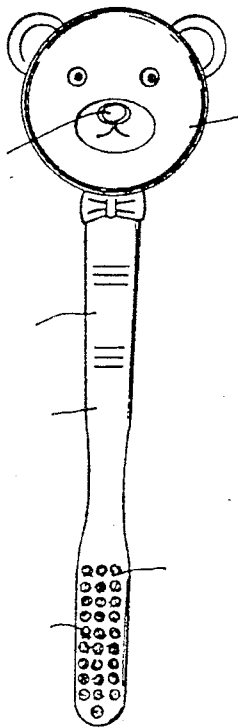

FIG-1

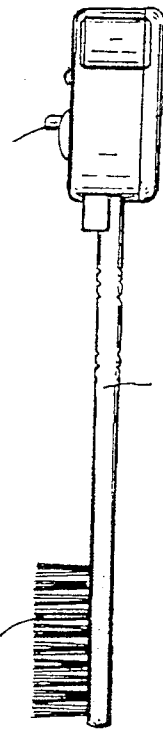

FIG-3

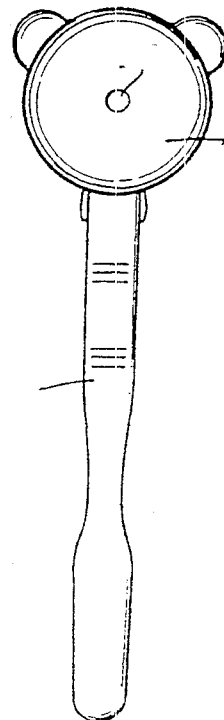

FIG-2

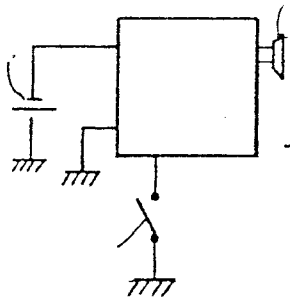

FIG-8

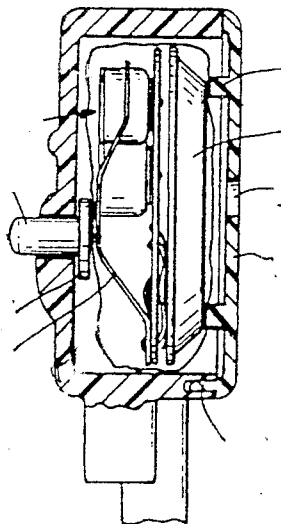

FIG-7

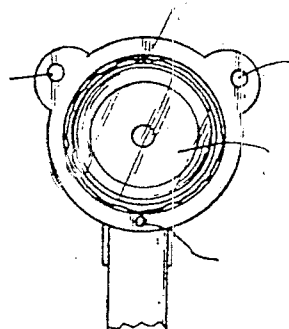

FIG-6